

A review of thermal barrier coating effects on diesel engine performance and components lifetime

M Azadi^{1,2}, M. Baloo^{2,3}, G. H. Farrahi^{*1}, S. M. Mirsalim^{2,3}

¹Materials Life Estimation and Improvement Laboratory, Sharif University of Technology, Tehran, Iran
²Irancell Power train Company (IP Co.), Tehran, Iran ³Amirkabir University of Technology, Tehran, Iran

*farrahi@sharif.edu

Abstract

In the present paper, a complete literatures review of thermal barrier coating applications in diesel engines is performed to select a proper type and to find coating effects. The coating system has effects on the fuel consumption, the power and the combustion efficiency, pollution contents and the fatigue lifetime of engine components. Usually there are several beneficial influences by applying ceramic layers on the combustion chamber, including the piston, the cylinder head, the cylinder block, intake and exhaust valves by using a plasma thermal spray method. Several disadvantages such as producing nitrogen oxides also exist when a coating system is used. In this article, all effects, advantages and disadvantages of thermal barrier coatings are investigated based on presented articles.

Keywords: diesel engine, thermal barrier coating, plasma spray, fuel consumption, fatigue lifetime

1. INTRODUCTION

Nowadays several research programs, in automotive industries, are carrying out in order to decrease engine fuel consumption and pollution. Design of diesel engines with lower heat rejection, by applying thermal barrier coating (TBC) is increasing according to fast increase in fuel costs, decrease in fuel production with high quality and environmental problems. Normally, in diesel engines about 19-22 percent of fuel energy is rejected to coolant fluid. Using TBC can reduce this heat loss and lead to better thermal efficiency. Also engine components durability can be improved. Therefore, better combustion, lower pollution, higher thermal efficiency and good fatigue lifetime are the results of using proper TBC in engine combustion chamber and exhaust system.

A major breakthrough in diesel engine technology has been achieved by the pioneering work done by Kamo and Bryzik since 1978 to 1989 as the first persons in introducing TBC system for engines [1-7]. Kamo and Bryzik used thermally insulating materials such as silicon nitride for insulating different surfaces of the combustion chamber.

Many researchers have carried out a large number of studies on design of diesel engines with lower heat

rejection (LHR) by using thermal barrier coating (TBC). Some of them are experimental work and many are theoretical studies. In the case of LHR engine almost all theoretical studies predict improved performance and fuel economy but some experimental studies show different image. The diesel engine generally offers better fuel economy than its counterpart petrol engine. Even the diesel engine rejects about two thirds of the heat energy of the fuel, one-third to the coolant, and one third to the exhaust, leaving only about one-third as useful power output. Theoretically, if the heat rejected could be reduced, then the thermal efficiency would be improved, at least up to the limit set by the second law of thermodynamics. LHR engines aim to do this by reducing the heat lost to the coolant.

In this study, the literatures review of TBC application in engines is performed to investigate all effects of TBC systems on engine performance and components lifetime. As a result, by considering the application of this kind of ceramic coating which is made on combustion chamber, dependent on the diesel engine type, fuel consumption is reduced, power and combustion efficiency is increased, pollution contents is decreased, and the fatigue lifetime of engine components is improved.

2. General Review

The diesel engine with its combustion chamber walls insulated by ceramics is referred to as LHR engine. Most of researchers have concluded that insulation reduces heat transfer, improves thermal efficiency, and increases energy availability in the exhaust. However contrary to the above expectations some experimental studies have indicated almost no improvement in thermal efficiency and claim that exhaust emissions deteriorated as compared to those of the conventional water-cooled engines.

Numerous simulation studies have been carried out to analyze the performance of the insulated engine. These simulation works predict definite improvement in the thermal performance of LHR engines over the conventionally cooled engines. In most of the cases simulations are performed on turbocharged, heavy duty, high speed and multi cylinder diesel engines. In some cases simulations are carried on single cylinder, light duty and direct injection diesel engines. Some of the simulations have included turbo compound systems and Rankin bottoming cycle (heat recovery systems). The specific fuel consumption improvement varies from 2 to 12 % [8-17]. This variation is mainly due to different amount of reductions in-cylinder heat rejections effected by degrees of insulations and different quantities of energy recovered from the exhaust.

The use of reduced heat rejection in diesel engines is least useful in naturally aspirated engines, more useful in turbocharged engines. In order to obtain better performance over a wide range of engine loads it becomes necessary to match the engine with a

turbocharger. As general, Winkler et al. [8-9] reported ten years of experience for the role of ceramic coatings on a diesel engine (Cummins) in reducing automotive emissions and improving combustion efficiency (Table 1).

In the next parts of this study, effects of the TBC system on the fuel consumption, emissions (including nitrogen oxides, smoke, un-burned hydrocarbon and carbon monoxide), the engine performance (including volumetric and thermal efficiency), the temperature distribution, the stress field and the fatigue lifetime are presented.

3. Fuel Consumption

Numerous investigators have modeled and analyzed the effects of in-cylinder thermal insulation on fuel consumption. The level of improvement that has been predicted ranged from 2 to 12 %. Kamo et al. [10] Test results indicate that coatings on the cylinder liner bore produced a reduction in fuel consumption while coatings on the piston and cylinder head-face surface were more effective in reducing heat rejection (Fig. 1). Uzan et al. [11] reported 2% decrease in the engine specific fuel consumption with TBCs. Murthy et al. [12] indicate that LHR engine showed deteriorated performance at recommended injection timing and pressure and improved performance at advanced injection timing and higher injection pressure, when compared with conventional engine (CE). At peak load operation, brake specific fuel consumption (BSFC) decreased by 12%.

Table 1: Ten years of the experience for the TBC application [8-9]

Properties	Variation Type	Maximum variation amount (%)
Fuel consumption	Decrease	11
Engine lifetime	Increase	20
Engine power	Increase	10
Emission	Decrease	20-50
Particle	Decrease	52
Oil consumption	Decrease	15
Engine noise	Decrease	3 (db)
Reliability	Increase	-
Components temperature	Decrease	100 (°C)
Valves lifetime	Increase	300
Costs	Decrease	20

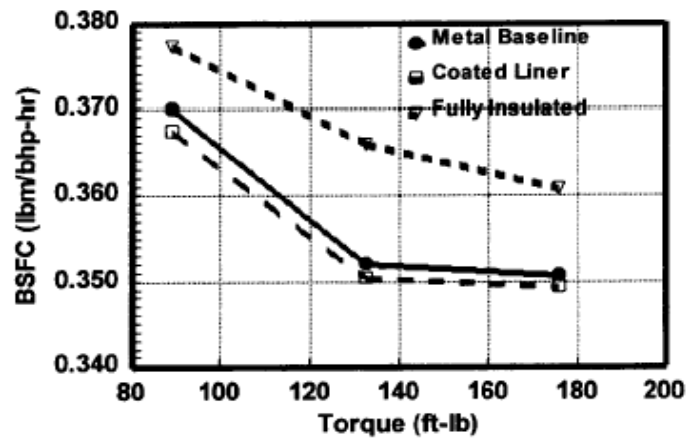

Fig1. The fuel consumption versus the torque at a constant speed, 1400 rpm [10]

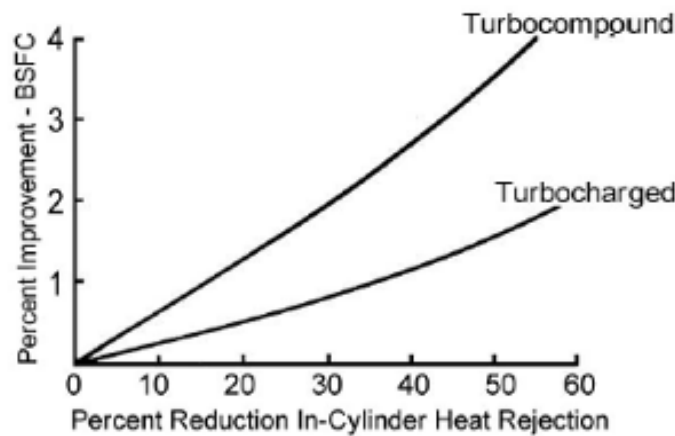

Fig2. The effect of the insulation on the fuel consumption [13]

Thring [13] stated that comparison of SFC between baseline and LHR engine should be done carefully, because reducing the heat rejection affects other engine operating parameters such as volumetric efficiency, air-fuel mixing and etc., which in turn affect fuel consumption. Hence it is felt that, comparison between the two engines should be made at same engine operating conditions and same engine operating parameters. In general, it has been reported that fuel consumption of, naturally aspirated LHR engine is in the range of 0 to 10% higher, turbocharged LHR engine in the order of 0 to 10% lower and turbo-compounded LHR engine in the order of 0 to 15% lower, when compared with the conventional cooled engine (Fig. 2).

Buyukkaya et al. [14] showed that 1-8% reduction in brake specific fuel consumption could be achieved by the combined effect of the thermal barrier coating (TBC) and injection timing. The investigation of Alkidas [15] has shown that the fuel economy of the LHR engine is of the same level as that of water

cooled engine at the medium load, but deteriorated significantly at the high load condition. He attributed this to increased temperature of the combustion chamber walls, thus also increasing the temperature of the fuel issuing from the heated nozzle orifice resulting in the reduced fuel viscosity. This caused a heavy leakage fuel inside the nozzle and extended injection duration as well. Admitting the need for tuning of the fuel injection system for LHR engine operation, he optimized an injector tip configuration and achieved equal or superior fuel consumption.

Assanis et al. [16] have shown that with proper adjustment of the injection timing it is possible to partially offset the adverse effect of insulation on heat release rate. Their data have shown that reducing heat rejection from the cylinder, shift the combustion from pre-mixed towards diffusion. They have shown that by advancing the timing, the LHR engine achieves the same pre-mixed heat release rate. Injection pressure and rate can also offset the adverse effect of insulation. Sun et al. [17] have shown that decrease in

pre-mixed combustion by about 75% in an insulated engine increases the BSFC by about 9%.

4. Emissions

4-1) Unburned Hydrocarbon and Carbon Monoxide Emission

In this section, the unburned hydrocarbon (UHC) and carbon monoxide (CO) emissions are investigated. The emission of unburned Hydrocarbon from the LHR engines is more likely to be reduced because of the decreased quenching distance and the increased lean flammability limit. The higher temperatures both in the gases and at the combustion chamber walls of the LHR engine assist in permitting the oxidation reactions to proceed close to completion. Most of the investigations show reduction in HC level [18].

Also many investigations indicate lower level of CO emissions. They attribute this to high gas temperature and combustion chamber walls. The reduced level of pre-mixed combustion in the insulated engine decreases the initial production of CO and the higher temperatures during diffusion combustion accelerate the oxidation of CO [18].

4-2) Nitrogen Oxides and Smoke

Nitrogen oxides (NO_x) are formed by chain reactions involving Nitrogen and Oxygen in the air. These reactions are highly temperature dependent. Since diesel engines always operate with excess air, NO_x emissions are mainly a function of gas temperature and residence time. Most of the earlier investigations show that NO_x emission from LHR engines is generally higher than that in water-cooled engines. This could be due to higher combustion temperature and longer combustion duration. Murthy et al. [12] indicate that Smoke levels increased by 16% and NO_x levels by 34% with LHR engine at an injection timing of 32°BTDC and an injection pressure of 270 bars, in comparison with CE (conventional engine) operating at an injection timing of 27°BTDC, and an injection pressure of 190 bars. Buyukkaya et al. [14] indicate NO_x emissions were obtained below those of the base engine by 11% for 18°BTDC injection timing.

The Investigation of Alkidas [15] reports an increase in the LHR engine NO_x emissions and concluded that diffusion burning is the controlling factor for the production of NO_x. Almost equal number of investigations report declining trend in the level of emission of NO_x, For example Ramu et al.

[19] showed that the combined effect of thermal barrier coating plus fuel additive shows better performance and simultaneously reduces the smoke and NO_x emission.

Fig. 3 shows the emission of NO_x against brake power of the standard engine and TBC engine. The result shows that NO_x emission is significantly reduced in the coated engines. The main cause in lowering NO_x emission is due to late combustion, because of change in the delay period. Due to the effect of delay period, the heat release diagram centroid shifts away from TDC, as a result of drop in pressure rise during combustion. Since the peak pressure rise is lower for the above reason, assuming the same value of mass, the peak gas temperature may also be lower near TDC, resulting reduced NO_x formation. The same trend is observed by Assanis et al. [16] during their experiments. They found lower NO_x level for a LHR engine than the standard engine. It is found that approximately 500 ppm NO_x emission reduced for ZrO₂-Al₂O₃ coated engine at maximum brake power. Further it is found that SiC coated engine reduces the NO_x emission about 800 ppm at maximum brake power against the standard engine.

Earlier investigations show that smoke and particulates emission level increased in some cases and decreased in a few others. The results obtained by Wade et al. [20] show significant reduction in smoke emission. They attribute this to enhanced soot oxidation, which was made possible by both the high combustion temperature and the intense turbulence created by the reversed squish. However, investigations carried out at by Ramu et al. [19] show increased level of smoke. They attribute it duo to the lengthening of combustion duration, smoke emission from thermal barrier coated engine was increased. At maximum brake power smoke density of the standard engine is 55 HSU (Hart-ridge Smoke Unit) and it is less when compare to coated engines by 15 HSU.

5. Engine Efficiency

5-1) Volumetric Efficiency

The volumetric efficiency is an indication of breathing ability of the engine. It depends on the ambient and operating conditions of the engine. Reducing heat rejection with the addition of ceramic insulation causes an increase in the temperature of the combustion chamber walls of an LHR engine. The volumetric efficiency should drop, as the hotter walls and residual gas decrease the density of the inducted air. As expected all the investigations such as Thring [13], Assanis et al. [16], Gatowski [21], Miyairi et al. [22], and Suzuki et al. [23], on LHR engine show

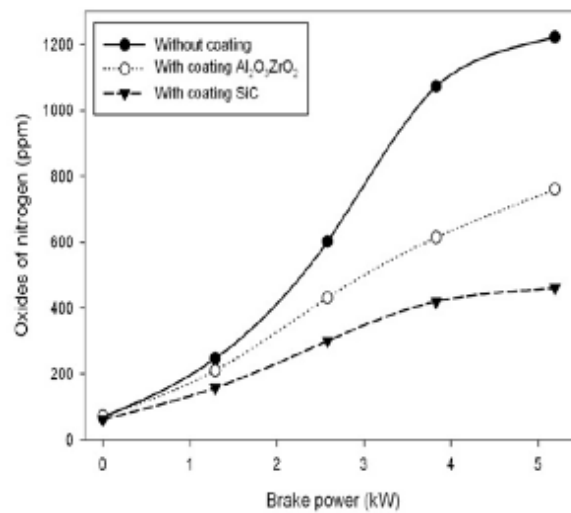

Fig3. The amount of nitrogen oxides against the brake power [19]

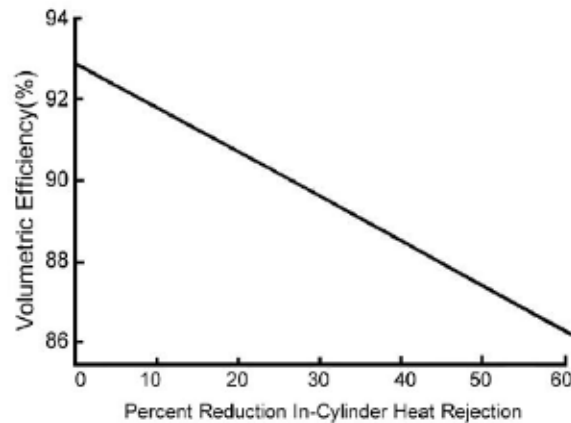

Fig4. The percent of the reduction in the cylinder heat rejection [23]

decreased volumetric efficiency (Fig. 4). The deterioration in volumetric efficiency of the LHR engine can be prevented by turbo-charging and that there can be more effective utilization of the exhaust gas energy.

5-2) Thermal Efficiency

The improvement in engine thermal efficiency by reduction of in-cylinder heat transfer is the key objective of LHR engine research. Much work has been done at many research institutes to examine the potential of LHR engines for reducing heat rejection and achieving high thermal efficiency. Researchers such as Thring [13], Alkidas [15], Havstad et al. [24], Moore et al. [25], Morel et al. [26], and many others have reported improvement in thermal efficiency with

LHR engine. They attribute this to in-cylinder heat transfer reduction and lower heat flux.

However investigations of others such as Cheng et al. [27], Woschni et al. [28], Furuhashi et al. [29], Dickey [30] and some others report that thermal efficiency reduces with insulation. They all attribute this to an increase in the convective heat transfer coefficient, higher heat flux (increase in in-cylinder heat transfer) and deteriorated combustion. The in-cylinder heat transfer characteristics of LHR engine are still not clearly understood. Thus the effect of combustion chamber insulation on reducing heat rejection and hence on thermal efficiency is not clearly understood as on date.

Hoag et al. [31], Sudhakar [32], Yoshimitsu et al. [33], and Yonushonis [34] have reported improvement in the reduction of fuel consumption and in the thermal efficiency of LHR engine.

The effects of ceramic coating on the performance of the diesel engine were investigated by Taymaz [35-36]. The combustion chamber surfaces, cylinder head, valves and piston crown faces were coated with ceramic materials. The layers were made of CaZrO_3 and MgZrO_3 and plasma coated onto the base of the NiCrAl bond coat. The ceramic-coated research engine was tested at the same operation conditions as the standard (without coating) engine. The results showed that the increase of the combustion temperature causes the effective efficiency to rise from 32% to 34% at medium load and from 37% to 39% at full load and medium engine speeds for ceramic-coated engine while it increases only from 26% to 27% at low load. The values of the effective efficiency are slightly higher for the ceramic-coated case as compared to the standard case (without coating).

6. Durability

Levy and Macadam [37] coated partially stabilized zirconia ceramic thermal barrier by plasma sprayed over an MCrAlY (M: metal) bond coat on the valve faces and tulips, piston crowns and cylinder heads of two medium speed diesel engines to a specified total thickness of 0.4 mm. One engine was operated for 500 hours on a test stand using a cyclic range of throttle settings that was representative of a locomotive engine's operation. The other engine was operated in a towboat for 9000 hours of service on the Inland Rivers. Coating performance analyses on several parts after the service show that coatings applied to piston crowns and cylinder heads generally performed in an acceptable manner. One type of

coating on a valve face performed acceptably without coating loss or degradation. Two other types of coatings on valve faces failed for identifiable reasons. Pre-alloyed 8% Y_2O_3 - ZrO_2 powders were preferable for plasma spraying of coatings on diesel engine combustion zone components. The 22% MgO - ZrO_2 coatings applied to valves became depleted of MgO and underwent a major transformation to the monoclinic phase during service which resulted in failure by spalling.

Overall, the durability of the coatings in a diesel engine combustion zone operating environment was promising. It means that properly applied partially stabilized zirconia thermal barrier coatings could withstand the service environment of a medium speed diesel engine combustion zone for at least 9000 hours [37].

Saad et al. [38] coated the Cummins ISB-305 engine to check the durability of components in the test rig. The engine modifications included piston crown coated with high temperature polymer base thermal barrier coating, piston skirt coated with solid lubricant as tribological coating, piston pin coated with diamond like carbon (DLC) coating, head faces coated with thermal barrier coating, intake and exhaust ports and valves coated with thermal barrier coating, exhaust manifold coated with thermal barrier coating, turbine housing and turbine wheel coated with thermal barrier coating, and cylinder liner coated with dual function thermal barrier and tribological coating (Fig. 5). Current engine tests showed the high temperature polymer based TBCs display greater potential of the reliability, the accessibility, the maintainability and the durability goals.

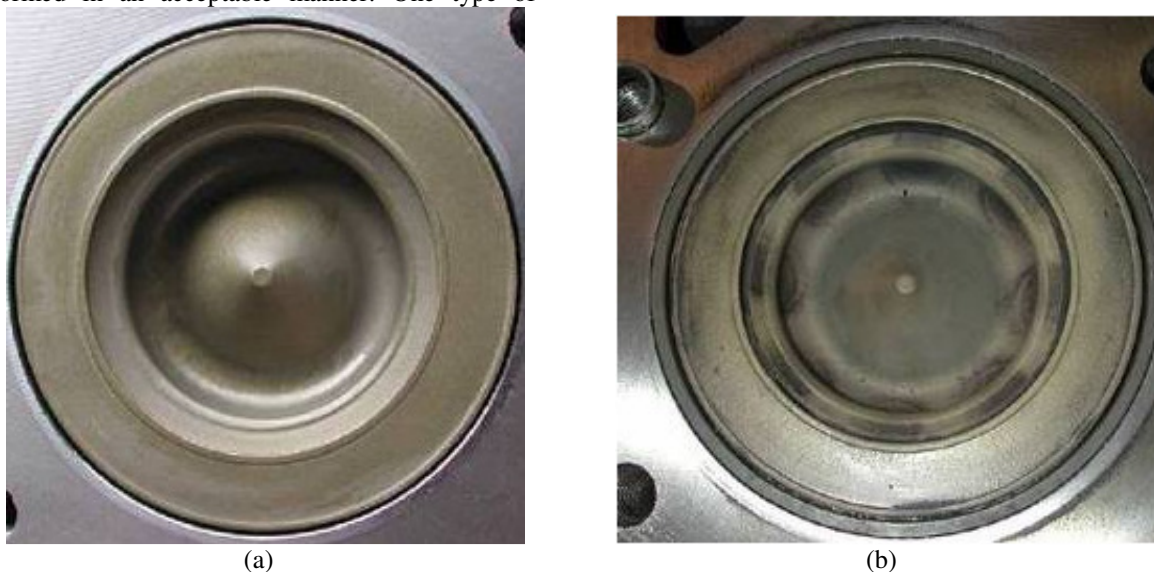

Fig5. The engine piston of Cummins ISB-305 coated with HTP TBC (a) before and (b) after the engine test [38]

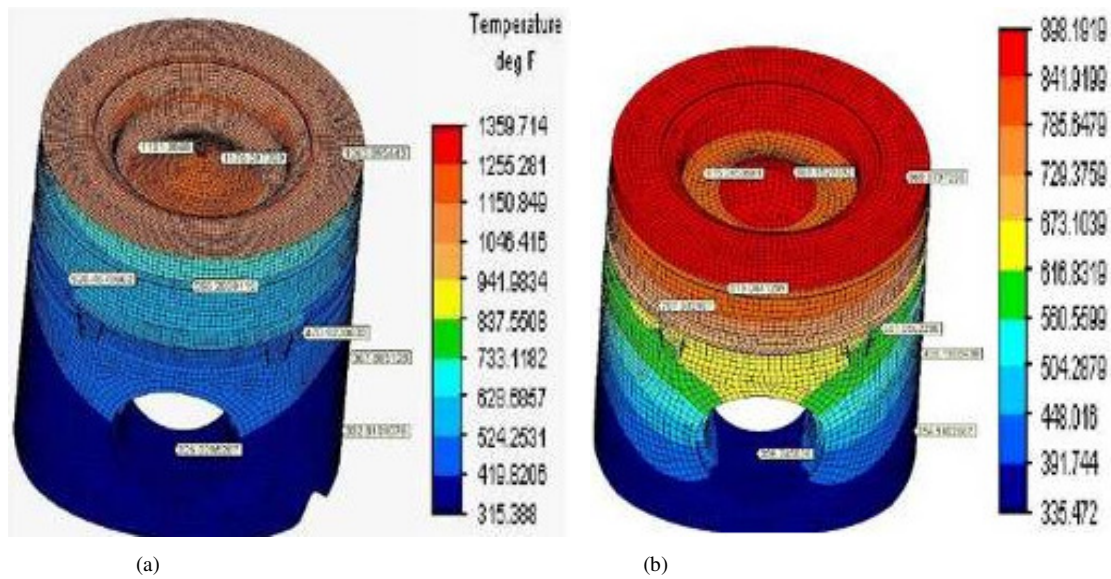

Fig6. The temperature distribution of (a) coated and (b) uncoated Cummins ISB piston [38]

7. Stress Distribution and Fatigue Analysis

For this part of the article, several researches has been presented but not in engine applications. Several scientists have reported damage mechanisms [39-40], the crack growth [41], the damage evaluation [42-43], the failure analysis [44-45], the residual stress [46], the fatigue lifetime [47-48], the multiaxial analysis [49-50], the stress distribution [51-55] and the effect of coating layers [56-57], in turbine applications. These articles performed on superalloys under thermal shock fatigue (TSF), low cycle fatigue (LCF) and thermo-mechanical fatigue (TMF) loadings.

Research and development (R&D) and analysis were conducted on aluminum alloy piston for high output turbocharged diesel engine coated with TBC by Saad et al. [38]. The finite element analysis (FEA) was used on the piston to compare heat distribution on a coated and uncoated piston crown. The thermal boundary conditions used in the analyses were based on modified Cummins ISB diesel cycle simulation results for a brake mean effective pressure level of 300 psi, and intake manifold temperature of 400°F. Oil sump temperatures were set at 300°F. Fig. 6 shows the temperature distribution on the piston coated and uncoated.

After steady state was achieved and according to the results in Fig. 6, a maximum temperature of 1176°F was seen at the top of the piston. Also, temperatures of 596°F, 520°F and 470°F were recorded at the top, second and the oil ring grooves, respectively. The coating reduced the heat transfer from the piston crown to the bottom of the piston. It is clear that the heat kept around the piston crown. The

heat flux at the top of the piston was 11 Btu/min-in² [38]. Consider the uncoated piston; a temperature of 1485°F was applied to the uncoated piston crown under the same condition as the coated piston. After steady state was achieved a maximum temperature of about 870°F was observed. The heat flux at the top of the piston was approximately 22 Btu/min-in². On the bottom of the piston, a maximum temperature of 683°F and at the skirt area temperature of around 350°F was observed. Also, temperatures of 815°F, 707°F and 601°F were recorded at the top, second and the oil ring grooves, respectively [38]. It is clear that there is a large temperature drop for the coated piston due to the thermal barrier coating applied on the crown surface. Also, the piston ring groove temperatures for the coated piston are less than the piston grooves of the uncoated piston. Although the surface temperature of coated piston crown is more than uncoated one, but also the temperature gradient is reduced for coated piston in comparison with uncoated one. This can cause less thermal stresses.

Cerit [58] determined the temperature and the stress distributions in a partial ceramic coated spark ignition (SI) engine piston. Effects of coating thickness and width on temperature and stress distributions were investigated including comparisons with results from an uncoated piston by using finite element method. It was observed that the coating surface temperature increase with increasing the thickness in a decreasing rate. Surface temperature of the piston with 0.4 mm coating thickness was increased up to 82°C (Fig. 7). At the top surface, von Mises stress distributions versus radial distance for uncoated and coated pistons with various thickness

values are shown in Fig. 8 (a). In the upper bond coat surface, defined EF line (at the bond coat-substrate interface), the shear stress distributions versus radial coating distance for thermal barrier coated pistons are shown in Fig. 8 (b). Numerical simulations clearly showed that the temperature distribution was a function of coating thickness. Temperature developed at the surface of coated region is significantly higher than that of the uncoated piston surface. It increases sharply within the coated region of all models with various coating thicknesses and maximum temperature at the surface of 0.5 mm thick coating was found to be 311°C, which is higher by 34% compared to uncoated piston. For the same coating thickness, increasing the coating width does not affect surface temperature.

Maximum stress is a function of coating thickness. The maximum normal stress, which may cause surface crack, takes place at the middle of the bottom surface of the ceramic coating width in radial direction. When the coating thickness increases gradually, it moves towards the inner edge of the coating. The other maximum normal stress which causes spalling of the ceramic top coat from the bond coat occurs on the bond coat interface. The von Mises stress decreases with increasing coating thickness. The shear stress which causes lateral cracks increases with the coating thickness increase and reaches its maximum level at the inner edge of the coated region at the substrate interface. Finally, it was found the optimum thickness for the ceramic coating was slightly below 1 mm [58]

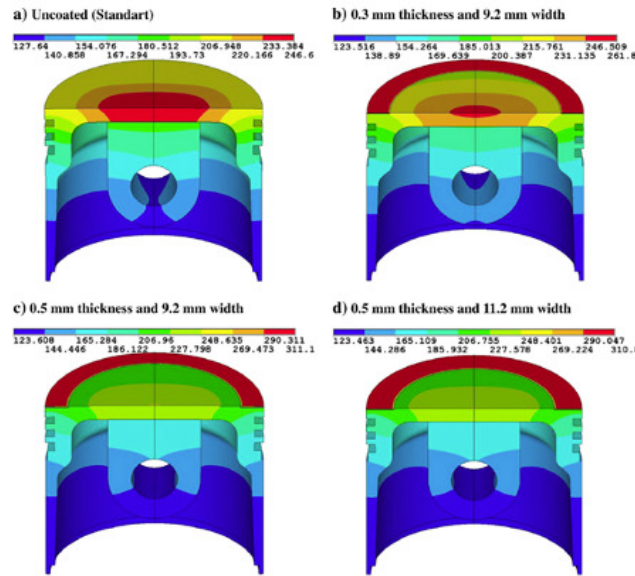

Fig7. The temperature distributions on the pistons of a spark ignition engine [58]

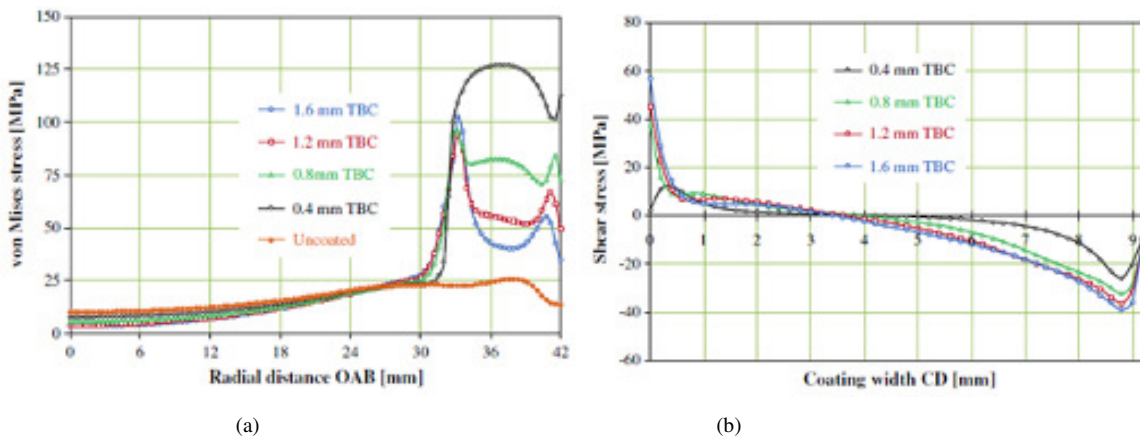

Fig8. (a) The normal stress distribution with the coating thickness at the top coat surface and (b) the shear stress distribution with the coating thickness at the bond coat surface [58]

Hejwowski and Weronki [59] studied temperature and stress distributions within the coated pistons were evaluated analytically by means of the Cosmos/Works finite element method (FEM) code. They used three types of coatings including NiCrAl bond coat 0.15 mm thick, Al₂O₃-40%TiO₂ 0.35 mm thick; NiCrAl bond coat 0.15 mm thick, ZrO₂-8%Y₂O₃ 0.3 mm thick; and NiCrMo bond coat 0.15 mm thick, Al₂O₃-40%ZrO₂ 0.25 mm thick. Results of FEM calculations showed that the optimum thickness of the TBC is slightly below 0.5 mm.

Azadi et al. [60-64] presented the optimization of plasma thermal spray parameters and coating thickness (changing between 300 to 800 microns) under bending and thermal shock tests. Also, thermo-mechanical fatigue analysis of coated specimens was performed. They used a typical TBC system consists of 3 layers including the substrate made of cast aluminum alloy, A356.0-T7 (8 hours solution at 525°C, water quench and 3 hours aging at 230°C) which is used in cylinder head diesel engines, the metallic bond coat made of NiCrAlY, and the Ytria

stabilized Zirconium (YSZ) TBC with typical composition ZrO₂-8wt%Y₂O₃. The results showed 450 microns for coating thickness in diesel engine applications had the superior fatigue lifetime due to less thermal stress in comparison with thinner thickness. Fig. 9 shows three fatigue lifetime types (Ni: cracking on surface, Nf: cracking between layers and Nb: separation) versus the coating thickness.

Rad et al. [65] used finite element model of a coated cylinder head to calculate temperature and stress distributions. Their results are shown in Fig. 10 including temperature and stress distributions in the coated cylinder head. They illustrated that the temperature of the substrate reduced up to 80°C when the TBC system was used. Also, the Von-Mises stress decreased about 20 (MPa) by using the TBC system. In the coated cylinder head, maximum stress occurred in the bond coat layer. This could result in the crack initiation in the TBC system which was in a quite acceptable accordance with observed failure mechanisms under thermal shock tests, in the literature [60-64].

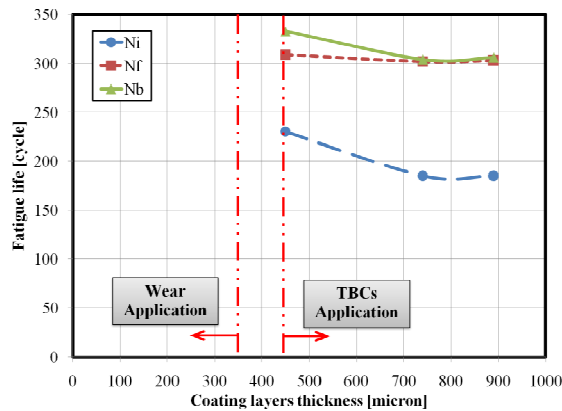

Fig9. The fatigue lifetime of coated specimens versus the thickness [60-64]

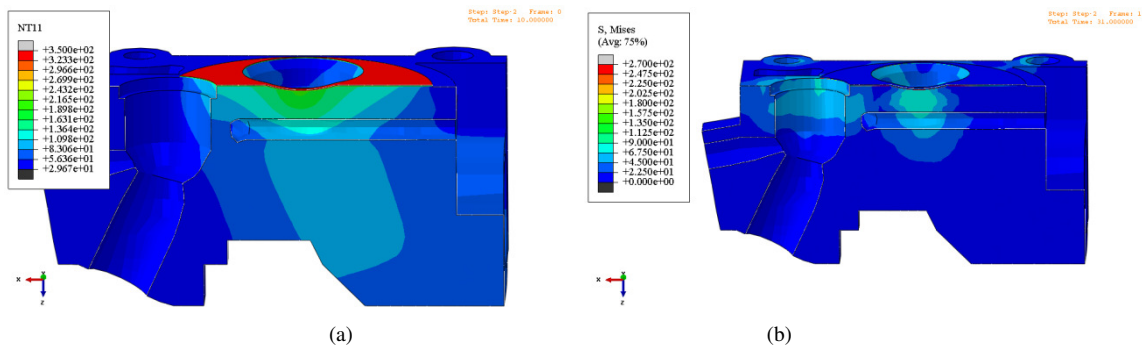

Fig10. The finite element results in the coated cylinder head (at the valves bridge) including (a) the Von-Mises stress distribution and (b) the temperature distribution

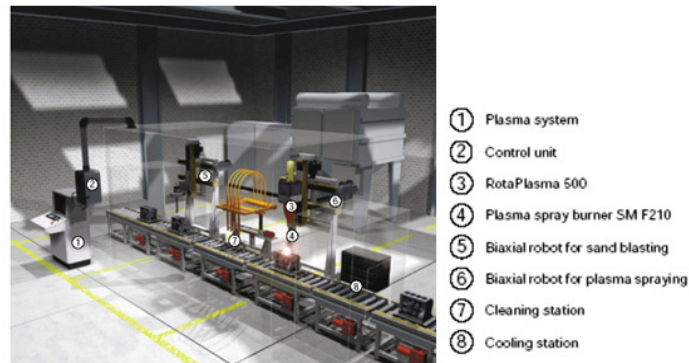

Fig11. The production line for the coating of the engine block by the plasma burner [66]

8. Feasibility Study

Although the most real application of TBC systems have been in race cars, but also nowadays coating layers are used in some engines. Volkswagen AG (VW) Company has made coated engines in the mass production (Fig. 11) such as four cylinder diesel engines of the new VW Lupo FSI in corporate with a coating company, Sulzer Metco to coat cylinder liners [66-67].

Swain Tech. Company has also remained the coating industry leader by continually developing coatings that allow customers to achieve power and durability gains. They coated pistons when they had their engines overhauled have benefited from increased power and better fuel mileage. The payback on the coatings is immediate. A typical CAT or Cummins power unit gets about six miles per gallon and hauls about 100,000 miles per year. With the current cost of diesel fuel, the costs of the coating would pay back by fuel saving alone in just a couple of months. The typical annual fuel savings will pay for the cost of the coatings four times over in just one year [68]. In mass productions, a plasma thermal spray machine is needed to be added in the production line. This costs almost 7 million Dollars which will be back in next 2 years by considering the costs of initial coating materials [69].

9. Conclusion

In this article, effects of the TBC system on the engine performance and the components lifetime are reviewed in diesel engine applications. As a results, a proper type of the coating system could be created from two layers of coatings; including a layer made of NiCrAlY with 150 microns thickness and another layer made of ZrO₂-8%Y₂O₃ with 300 microns thickness by using the plasma thermal spray method.

In this case, the fuel consumption reduces, the engine power and the combustion efficiency increases, pollution contents decrease, and the fatigue lifetime of engine components such as the cylinder head and the piston improves due to the reduction of 100°C in the surface temperature and also the reduction of the temperature gradient and thermo-mechanical stresses of the substrate.

References

- [1]. Kamo R. and Bryzik W., 1978, "Adiabatic turbo-compound engine performance prediction", SAE International, Paper No. 780068
- [2]. Kamo R. and Bryzik W., 1979, "Ceramics in heat engines", SAE International, Paper No. 790645
- [3]. Kamo R. and Bryzik W., 1981, "Cummins-TRADOCOM adiabatic turbo-compounded engine program", SAE International, Paper No. 810070
- [4]. Bryzik W. and Kamo R., 1983, "TACOM/Cummins adiabatic engine program", SAE International, Paper No. 830314
- [5]. Kamo R. and Bryzik W., 1984, "Cummins/TACOM advanced adiabatic engine", SAE International, Paper No. 840428
- [6]. Sekar R.R. and Kamo R., 1984, "Advanced adiabatic diesel engine for passenger cars", SAE International, Paper No. 840434
- [7]. Kamo R., Woods M.E. and Bryzik W., 1989, "Thin thermal barrier coating for engines", United States Patent, Patent No. US4852542
- [8]. Winkler M.F., Parker D.W. and Bonar J.A., 1992, "Thermal barrier coatings for diesel engines: ten years of experience", SAE International, Paper No. 922438
- [9]. Winkler M.F. and Parker D.W., 1993, "The role of diesel ceramic coatings in reducing

- automotive emissions and improving combustion efficiency”, SAE International, Paper No. 930158
- [10]. Kamo R., Bryzik W., Reid M. and Woods M., 1997, “Coatings for improving engine performance”, SAE International, Paper No. 970204
- [11]. Uzun A., Cevik I. and Akcil M., 1999, “Effects of thermal barrier coating on a turbocharged diesel engine performance”, *Surface and Coatings Technology*, 116-119, 505-507
- [12]. Murthy P.V.K, Krishna M.V.S., Raju A., Prasad C.M. and Srinivasulu N.V., 2010, “Performance evaluation of low heat rejection diesel engine with pure diesel”, *International Journal of Applied Engineering Research*, 1 (3), 428-451
- [13]. Thring R.H., 1986, “Low Heat Rejection Engines”, SAE International, Paper No.860314
- [14]. Buyukkaya E., Engin T. and Cerit M., 2006, “Effects of thermal barrier coating on gas emissions and performance of a LHR engine with different injection timings and valve adjustments”, *Energy Conversion and Management*, 47, 1298-1310
- [15]. Alkidas A.C., 1989, “Performance and emissions achievements with an un-cooled heavy duty single cylindered diesel engine”, SAE International, Paper No.890144
- [16]. Assanis D., Wiese K., Schwarz E. and Bryzik W., 1991, “The effect of ceramic coatings on diesel engine performance and exhaust”, SAE International, Paper No. 910460
- [17]. Sun X., Wang W.G., Lyons D.W., and Gao X., 1993, “Experimental analysis and performance improvement of single cylinder direct injection turbocharged low heat rejection engine”, SAE International, Paper No.930989
- [18]. Jaichandar S. and Tamilporai P., 2003, “Low heat rejection engines - an overview”, SAE International, Paper No. 2003-01-0405
- [19]. Ramu P. and Saravanan C.G., 2009, “Effect of ZrO₂-Al₂O₃ and SiC coating on diesel engine to study the combustion and emission characteristics”, SAE International, Paper No. 2009-01-1435
- [20]. Wade W.R., Havstad P.H., Ounsted E.J., Trinkerand F.H. and Garwin I.J., 1984, “Fuel economy opportunities with an un-cooled DI diesel engine”, SAE International, Paper No.841286
- [21]. Gatowski J.A., 1990, “Evaluation of a selectively-cooled single cylindered 0.5-L diesel engine”, SAE International, Paper No.900693
- [22]. Miyairi Y., Matsuhisa T., Ozawa T., Oikawa H. and Nakashima N., 1989, “Selective heat insulation of combustion chamber walls for a DI diesel engine with monolithic ceramics”, SAE International, Paper No.890141
- [23]. Suzuki T., Tsujita M., Mori Y. and Suzuki T., 1986, “An observation of combustion of phenomenon on heat insulated turbocharged and inter-cooled DI diesel engines”, SAE International, Paper No.861187
- [24]. Havstad P.H., Garwin I.J. and Wade W.R., 1986, “Ceramic insert un-cooled diesel engine”, SAE International, Paper No.860447
- [25]. Moore C.H. and Hoehne J.L., 1986, “Combustion chamber insulation effect on the performance of a low heat rejection Cummins V-903 engine”, SAE International, Paper No.860317
- [26]. Morel T., Wahiduzzaman S. and Fort E.F., 1988, “Heat Transfer Experiments in an Insulated Diesel”, SAE International, Paper No.880186
- [27]. Cheng W.K., Wong V.W. and Gao F., 1989, “Heat transfer measurement comparisons in insulated and non-insulated diesel engines”, SAE International, Paper No.890570
- [28]. Woschni G., Spindler W. and Kolesa K., 1987, “Heat insulation of combustion chamber walls - a measure to decrease the fuel consumption of IC engines”, SAE International, Paper No.870339
- [29]. Furuhashi S. and Enomoto Y., 1987, “Heat transfer into ceramic combustion wall of internal combustion engines”, SAE International, Paper No.870153
- [30]. Dickey D.W., 1989, “The effect of insulated combustion chamber surfaces on direct-injected diesel engine performance, emissions and combustion”, SAE International, Paper No.890292
- [31]. Hoag K.L., Brands M.C. and Bryzik W., “Cummins/TACOM adiabatic engine program”, SAE International, Paper No. 850356
- [32]. Sudhakar V., 1982, “Performance analysis of adiabatic engine”, SAE International, Paper No.820431
- [33]. Yoshimitsu T., Toyama K., Sato F. and Yamaguchi H., 1984, “Capabilities of heat insulated diesel engine”, SAE International, Paper No.840431
- [34]. Yonushonis T.M., 1997, “Overview of thermal barrier coatings in diesel engines”, *Thermal Spray Technology*, 6 (1), 50-56
- [35]. Taymaz I., Cakir K. and Mimaroglu A., 2005, “Experimental study of effective efficiency in a ceramic coated diesel engine”, *Surface and Coatings Technology*, 200, 1182-1185

- [36]. Taymaz I., 2007, "The effect of thermal barrier coatings on diesel engine performance", *Surface and Coatings Technology*, 201, 5249-5252
- [37]. Levy A. and Macadam S., 1987, "The behavior of ceramic thermal barrier coatings on diesel engine combustion zone components", *Surface and Coatings Technology*, 30, 51-61
- [38]. Saad D., Saad P., Kamo L., Mekari M., Bryzik W. and Tasdemir J., 2007, "Thermal barrier coatings for high output turbocharged diesel engine", SAE International, Paper No. 2007-01-1442
- [39]. Zhang Y.H., Withers P.J., Fox M.D. and Knowles D.M., 1999, "Damage mechanisms of coated systems under thermo-mechanical fatigue", *Materials Science and Technology*, 15 (9), 1031-1037
- [40]. Rahmani Kh. and Nategh S., 2008, "Influence of aluminate diffusion coating on low cycle fatigue properties of Rene80", *Materials Science and Engineering*, A486, 686-695
- [41]. Jung A. and Schnell A., 2008, "Crack growth in a coated gas turbine superalloy under thermo-mechanical fatigue", *International Journal of Fatigue*, 30, 286-291
- [42]. Nuetzel R., Affeldt E. and Goeken M., 2008, "Damage evolution during thermo-mechanical fatigue of a coated monocrystalline nickel-base superalloy", *International Journal of Fatigue*, 30, 313-317
- [43]. Kitazawa R., Tanaka M., Kagawa Y. and Liu Y.F., 2010, "Damage evaluation of TBC system under in-phase thermo-mechanical tests", *Materials Science and Engineering*, B173, 130-134
- [44]. Tzimas E., Mullejansi H., Peteves S.D., Bressers J. and Stamm W., 2000, "Failure of thermal barrier coating systems under cyclic thermo-mechanical loading", *Acta Metallurgica*, 48, 4699-4707
- [45]. Zhang Y.Y., Deng H.X., Shi H.J., Yu H.C. and Zhong B., 2012, "Failure characteristic and life prediction for thermally cycled thermal barrier coatings", *Surface and Coatings Technology*, 206, 2977-2985
- [46]. Widjaja S., Limarga A.M. and Yip T.H., 2003, "Modeling of residual stresses in a plasma-sprayed zirconia/alumina functionally graded-thermal barrier coating", *Thin Solid Films*, 434, 216-227
- [47]. Traeger F., Ahrens M., Vassen R. and Stoeber D., 2003, "A life time model for ceramic thermal barrier coatings", *Materials Science and Engineering*, A358, 255-265
- [48]. Liu Y., Persson C. and Wigren J., 2004, "Experimental and numerical life prediction of thermally cycled thermal barrier coatings", *Journal of Thermal Spray Technology*, 13 (3), 415-424
- [49]. Bartsch M., Baufeld B., Heinzelmann M., Karlsson A.M., Dalkilic S. and Chernova L., 2007, "Multiaxial thermo-mechanical fatigue on material systems for gas turbines", *Materials Science and Engineering Technology*, 38 (9), 712-719
- [50]. Rauch M. and Roos E., 2008, "Life assessment of multiaxially cyclic loaded turbine components", *Fatigue and Fracture of Engineering Materials and Structures*, 31, 441-451
- [51]. Martena M., Botto D., Fino P., Sabbadini S., Gola M.M. and Badini C., 2006, "Modeling of TBC system failure: Stress distribution as a function of TGO thickness and thermal expansion mismatch", *Engineering Failure Analysis*, 13, 409-426
- [52]. Bialas M., 2008, "Finite element analysis of stress distribution in thermal barrier coatings", *Surface and Coatings Technology*, 202, 6002-6010
- [53]. Asghari S. and Salimi M., 2010, "Finite element simulation of thermal barrier coating performance under thermal cycling", *Surface and Coatings Technology*, 205, 2042-2050
- [54]. Ranjbar-Far M., Absi J., Mariaux G. and Dubois F., 2010, "Simulation of the effect of material properties and interface roughness on the stress distribution in thermal barrier coatings using finite element method", *Materials and Design*, 31, 772-781
- [55]. Ranjbar-Far M., Absi J., Shahidi S. and Mariaux G., 2011, "Impact of the non-homogenous temperature distribution and the coatings process modeling on the thermal barrier coatings system", *Materials and Design*, 32, 728-735
- [56]. Wang L., Wang Y., Sun X.G., He J.Q., Pan Z.Y. and Wang C.H., 2012, "Finite element simulation of residual stress of double-ceramic-layer La₂Zr₂O₇/8YSZ thermal barrier coatings using birth and death element technique", *Computational Materials Science*, 53, 117-127
- [57]. Wang L., Wang Y., Zhang W.Q., Sun X.G., He J.Q., Pan Z.Y. and Wang C.H., 2012, "Finite element simulation of stress distribution and development in 8YSZ and double-ceramic-layer La₂Zr₂O₇/8YSZ thermal barrier coatings during thermal shock", *Applied Surface Science*, 258, 3540-355

- [58]. Cerit M., 2011, "Thermo mechanical analysis of a partially ceramic coated piston used in an SI engine", *Surface and Coatings Technology*, 205, 3499-3505
- [59]. Hejwowski T. and Weronki A., 2002, "The effect of thermal barrier coatings on diesel engine performance", *Vacuum*, 65, 427-432
- [60]. Azadi M., Moridi A. and Farrahi G.H., 2011, "Optimization of plasma thermal spray parameters under bending loads by using design of experiment method", *International Conference on Advances in Materials and Processing Technologies*, Istanbul, Turkey, 13-16 July
- [61]. Moridi A., Azadi M. and Farrahi G.H., 2011, "Numerical simulation of thermal barrier coating system under thermo-mechanical loadings", *Word Congress on Engineering*, London, England, 6-8 July
- [62]. Moridi A., Azadi M. and Farrahi G.H., 2011, "Coating thickness and roughness effect on stress distribution of A356.0 under thermo-mechanical loadings", *Procedia Engineering*, 10, 1373-1378
- [63]. Moridi A., Azadi M. and Farrahi G.H., 2013, "Thermo-mechanical stress analysis of thermal barrier coating system considering thickness and roughness effects", *Surface and Coatings Technology*, doi:10.1016/j.surfcoat.2012.02.019
- [64]. Azadi M., Moridi A. and Farrahi G.H., 2012, "Optimal design experiment of plasma thermal spray parameters under bending loads", *International Journal of Surface Science and Engineering*, 6 (1-2), 3-14
- [65]. Rad M.R., Azadi M., Farrahi G.H., Thermal barrier coating effect on stress distribution of a diesel engine cylinder head, Accepted in 7th Iranian Student Conference on Mechanical Engineering, School of Mechanical Engineering, University of Tehran, Tehran, Iran, February 2013
- [66]. V.G. Raven, 1999, "Water-Cooled Volkswagen Performance Handbook", MBI Publishing Company
- [67]. G. Barbezat, R. Herber, 2001, "Breakthrough in improving car engine performance through coatings", *SULZER Technical Review*, 2, 8-11
- [68]. Swain Tech. Company, site address: <http://www.swaintech.com/>
- [69]. Azadi M., Moridi A., Hassani-Gangaraj S.M., Farrahi G.H., 2011, "Production of diesel engine cylinder heads with thermal barrier coating in order to reduce fuel consumption, increase power and efficiency, decrease pollutions and increase fatigue life of engine components", 3rd Sharif Business Plan Conference, Sharif University of Technology, Tehran, Iran