



Sensitivity Analysis of Different Parameters Affecting Thermal Contact Conductance

Mohsen Motahari Nezhad¹, Abbas Rahi²

¹ Ph.D. Candidate, Faculty of Mechanical & Energy Engineering, Shahid Beheshti University, A.C., Tehran, Iran

² Assistant Professor, Faculty of Mechanical & Energy Engineering, Shahid Beheshti University, A.C., Tehran, Iran

ARTICLE INFO

Article history:

Received : 13 Feb 2018

Accepted: 18 Mar 2019

Published:

Keywords:

Sensitivity analysis

Experimental setup

Exhaust valve

Internal combustion engine

ABSTRACT

In internal combustion engines, exhaust valve and its seat gain considerable temperature as the hot gases exit through them. So, the rate of heat transfer should be under control. In this study, the contact heat transfer coefficient has been estimated. An experimental study on an Air-Cooled internal combustion engine cylinder head has been considered. Using the measured temperatures of sensors located in specific locations of the exhaust valve and the seat and the method of linear extrapolation, the surface contact temperatures, and constant and periodic contact heat transfer coefficient were calculated. Also, a sensitivity analysis has been done to study the effects of different parameters of contact pressure, contact frequency, heat flux and cooling air speed on thermal contact conductance. The results show that between the major four considered parameters, the thermal contact conductance is more sensitive to the contact pressure, then the contact frequency, heat flux, and the cooling air speed are the most affecting parameters on thermal contact resistance.

* Mohsen Motahari Nezhad

1 Introduction

In closed valves, the heat is transferred mainly to the seat and the cylinder head cooling system and in an open state of the valve, the valve stem is the main way to the heat transfer. Without proper cooling, due to contact between the exhaust valve and its seat and the high temperature of the valve, valve and its seat are burned and deformed. Over the times and due to periodic contacts, this deformation causes the breaking of the seat and the filler. Also, by the accumulation of fine material especially carbon at the contacting surfaces, this material operate like a thermal barrier and prevents the valve cooling. As a result, valve burning and even knocking and pre-ignition is created and causes to non-complete combustion and increasing the environmental pollution. Therefore, due to the importance of the matter, it is important to control the temperature of the exhaust valve at the contact region. Currently, there is not an appropriate model for predicting the heat transfer rate between valve and seat for internal combustion engines.

Annand and Lanary [1] experimentally carried out a steady-state study on a simple valve. In their research, measurements were taken on a valve for the steady flow at different distances from the seat. Their results are quite acceptable and can be used for a real engine. They heated the valve by heater elements and it was cooled by the cold flow around the valve. The cooling system was so simple such that the total heat transfer rate could be calculated. Sonoda et al. [2] by using a heat pipe cooling method have carried out a good experimental study on diesel engine exhaust valves. Paradis et al. [3] investigated the heat transfer between the exhaust valve and seat in an aluminum air-cooled single-cylinder engine. They introduced a nonlinear dynamic model for thermal gas flow and heat transfer in the transient and steady state. Prediction of thermal behavior of the engine using this model has been already a basis for stating the periodic thermal contact model. An important purpose of this study was to investigate the contact resistance at the interface of the exhaust valve and seat. In their research, there was a strong concentrate on introducing the details of periodic thermal resistance at the

exhaust valve as a thermal model of the lumped parameter element to estimate its temperature. Shojaefard et al. [4, 5] have theoretically and experimentally studied the one-dimensional heat transfer at the contact surfaces of two rods that were coaxial. They used the linear system identification method to control the valve temperature. In this method, with the temperatures on both sides of the contact surface, the temperature of the contact region can be estimated theoretically. A thermal contact simulator was used for this purpose. Shojaefard et al. [6] have conducted an experimental study to determine the thermal contact conductance between two coaxial cylinders, as the exhaust valve and seat. In addition, the effect of contact frequency and contact pressure on thermal contact conductance were studied. The results showed that with increasing frequency, the contact heat transfer coefficient decreases. Mykhaylyk et al. [7] investigated the thermal contact at the copper-copper contacting surface without coatings in a vacuum environment. Their results showed that the thermal contact initially increases with increasing temperature, then thermal contact decreases with increasing temperature. Dongmei et al. [8] used the lumped parameter method, which is a transient and a non-contact method for measuring thermal contact resistance between two solids. It was concluded that the thermal contact resistance increases with increasing temperature. The contact pressure can increase the contact area, which can lead to reducing the thermal contact resistance. Shojaefard et al. [9] investigated the impact of contact frequency and contact pressure on the contact heat transfer coefficient. The results showed that increasing the stiffness of the spring or the contact pressure will increase dramatically the contact heat transfer coefficient. Motahari-Nezhad et al. [10] carried out the experiments aimed at analyzing thermally the exhaust valve in an air-cooled internal combustion engine for estimating the thermal contact conductance in fixed and periodic contacts. Using the methods of linear extrapolation and the inverse solution, the surface contact temperatures, and the fixed and periodic thermal contact conductance were calculated. Their results showed that the linear extrapolation and inverse methods have similar

trends, and based on the error analysis, they are accurate enough to estimate the thermal contact conductance. An adaptive neuro-fuzzy inference system (ANFIS) model for the prediction of thermal contact conductance between the exhaust valve and its seat has been proposed by Motahari-Nezhad et al. [11]. In their study, the capabilities of a neuro-fuzzy approach, namely ANFIS have been studied for estimating the rate of the heat transfer between the exhaust valve and its seat. In their study, it is shown that the ANFIS architecture can estimate the heat transfer rate between the exhaust valve and its seat very accurately. Shojaeefard et al. [12] carried out experimental investigation of thermal balance and valve cover heat transfer in a small internal combustion engine. In their study, valve cover heat transfer and thermal balance of an air-cooled engine was investigated experimentally. In order to carry out experiments, a single cylinder, air-cooled, four-stroke gasoline engine was applied. The engine was installed on proper chassis and equipped with measuring instruments. Temperature of different points of valve cover and exhaust gases was measured with the assistance of K-type thermocouples. Their experiments were conducted in various engine speeds. It was evaluated that for increasing brake power, fuel consumption will increase and it is impossible to prevent upward trends of wasted energies. In addition, it was resulted that, there is a reduction heat transfer to brake power ratio by increasing engine speed. Furthermore, it was found that, at higher engine speed, lower percentage of energy in form of heat transfer will be lost.

In the present study, the experimental device same as the setup used in reference [10] is used for sensitivity analysis of different parameters affecting thermal contact conductance. Different parameters of contact pressure, contact frequency, heat flux, and cooling air speed have been studied for sensitivity analysis.

coaxial hot and cold rods which were in periodic contact with each other. In this study, we have investigated the contact heat transfer at the exhaust valve and its seat in the actual geometry of an internal combustion engine. We have considered a Wave 125 motorcycle engine. In this study, we have investigated the engine without the combustion and elements are used for heating the exhaust valve [10].

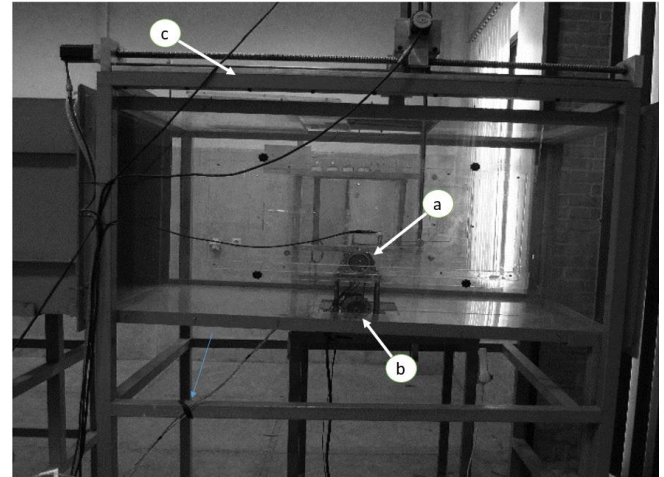

Figure 1. A picture of the test setup for thermal contacts between the exhaust valve and seat before placing thermal insulation. a) IC engine cylinder head, b) Electric motor, c) Wind tunnel test section

An experimental system that includes a cylinder head of an Air-Cooled internal combustion engine has been considered, which is shown in Figure 1. This system generally consists of two main parts: mechanical and electronic. Further details are described as follows. Various components of the mechanical section of the experimental setup for studying the thermal contact are shown in Figure 2. The hardware components and the details of the experimental setup can be found in reference [10].

2 Experimental Test Method

The study is based on the experimental investigation. Most of the studies conducted by researchers in the field of experimental simulation of the thermal contact have used two

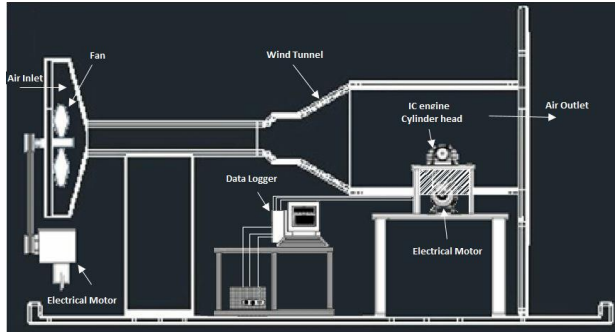
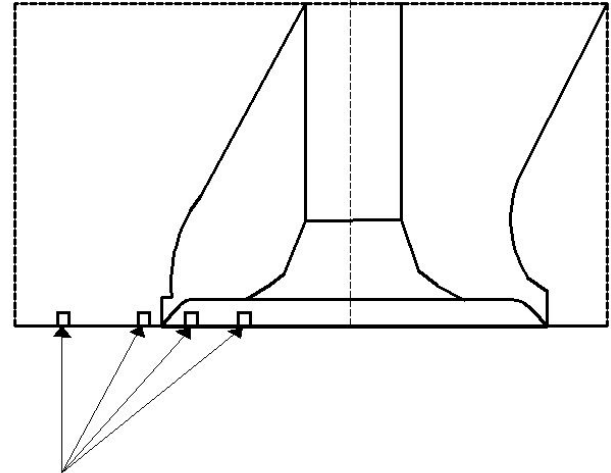

Figure 2. General schematic of the experimental system for thermal contact study

In order to evaluate the effect of contact frequency on the contact heat transfer, a Tamel S.R electric motor with a three-phase alternating current has been employed. The camshaft of internal combustion engine has been powered with an electric motor driven by a gear and a chain gear. In addition to controlling the engine speed, the variable frequency drive of VFD022B21A has been applied. To heat the valve, an electrical cartridge heater with a length of 60 mm, a diameter of 4 mm, and maximum power of 280 W has been used. The heater has been inserted in the head and inside of the valve. In this mode, the heater can only heat the valve head. Since the heater has been inserted in the middle of the valve, the heat flux will be distributed symmetrically in the valve head. K-type thermocouples of chrome–nickel with a diameter of 1 mm were applied. This type of thermocouple has the accuracy of $\pm 0.004 \times T$ ($^{\circ}\text{C}$) in the temperature range of -40 $^{\circ}\text{C}$ to 1000 $^{\circ}\text{C}$. The response time of the thermocouple is 0.15 s [10].



The locations of thermocouples

Figure 3. The location of thermocouples

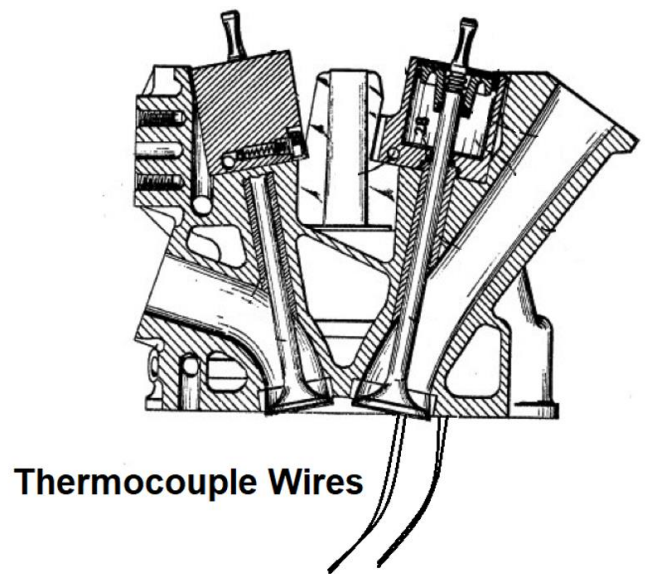

Thermocouple Wires

Figure 4. The procedure for thermocouple insertion and exiting the thermocouple wires

3 Linear Extrapolation Method

Contact heat transfer coefficient at steady state is calculated by [13]

$$h_c = \frac{q_c''}{T_{c1} - T_{c2}} \quad (1)$$

where

$$q_c'' = \frac{(k \frac{dT}{dx})_{Seat} + (k \frac{dT}{dx})_{Valve}}{2} \quad (2)$$

where $\frac{dT}{dx}$ is the temperature distribution, k is the thermal conductivity and q_c'' is the flux flowing at the contacting surfaces.

To obtain the surface temperature, using the linear extrapolation method, the temperature read by the thermocouples are approximated as a function of location and temperature distribution function are gained. The geometry and coordinates are shown in Figure 5.

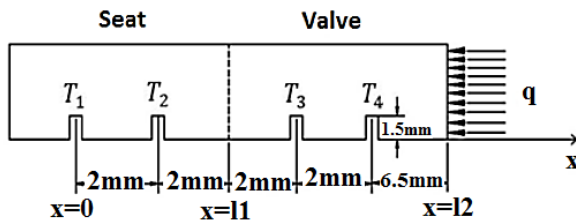

Figure 5. Geometry and coordinate [10]

4 Sensitivity Analysis

In order to identify the input parameters that have the most significant influence on the output, a sensitivity analysis technique called Relative Sensitivity (SL) is used. This technique assesses the relative sensitivity level of an independent variable (input parameter) on a dependent variable (output quantity), averaging across the levels of the other independent variables. In this paper, sensitivity analysis is done on four inputs and only one output parameter. The sensitivity level is calculated as [14]

$$SL_i = \frac{N_{al} - N_{Base}}{N_{Base}} \times 100 \quad (3)$$

where N_{Base} is the average of the dependent parameter along the calculating node based on the base value of the desired parameter, N_{al} is the average of that dependent parameter along the calculating node which is defined according to the percentage of the change in the determined parameter. Also, SL_i is the sensitivity level of the i^{th} parameter. The other input parameters are fixed. The input parameters are discussed following.

To determine the sensitivity of the input parameters on the output parameter, the input

parameters have been increased to 1, 2 and 3 percent and the effects of this changing have been investigated on the dependent parameter (thermal contact resistance) and the relative sensitivity has been calculated using equation 3.

5 Results and discussion

A sample of data acquired from the beginning of the test to reach the steady state for fix and periodic contact between the exhaust valve and seat with a frequency of 210 rpm according to the geometry shown in figure 5 are shown in Figures 6 and 7, respectively.

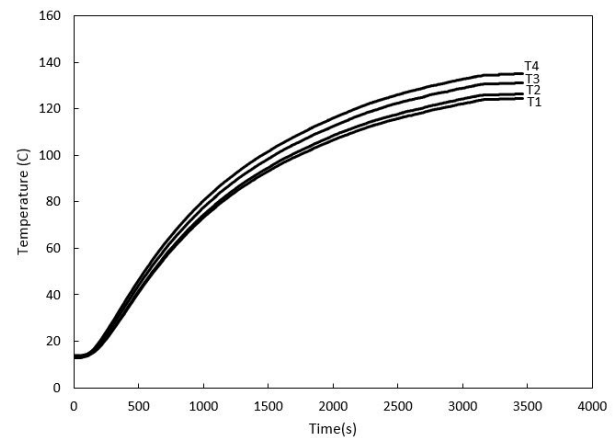

Figure 6. Temperature distribution for fix contact

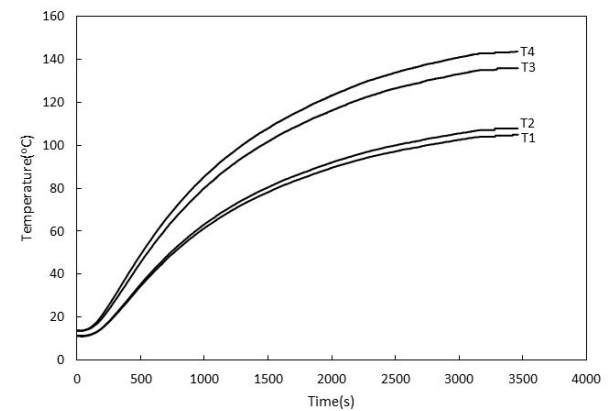

Figure 7. Temperature distribution in the valve and its seat for periodic contact with frequency of 210 rpm

By using the extrapolation method, the temperatures of contacting surfaces are calculated and the samples for fix and

periodic contact of 210 rpm are shown in Figures 8 and 9, respectively. Also, the average surface temperature at any given moment is defined as follows:

$$T_{av} = \left(\frac{T_{c1} + T_{c2}}{2} \right) \quad (4)$$

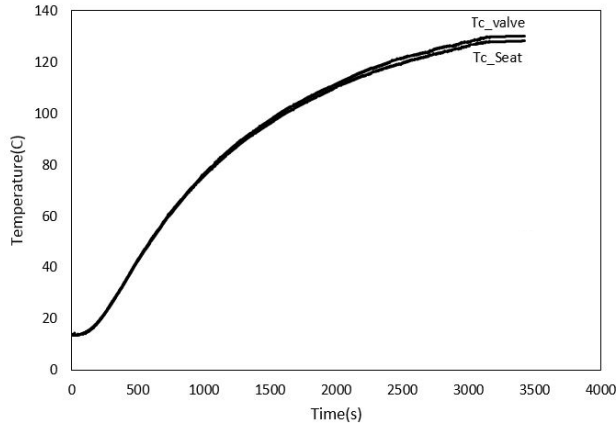

Figure 8. The temperature of the contact surfaces for fix contact

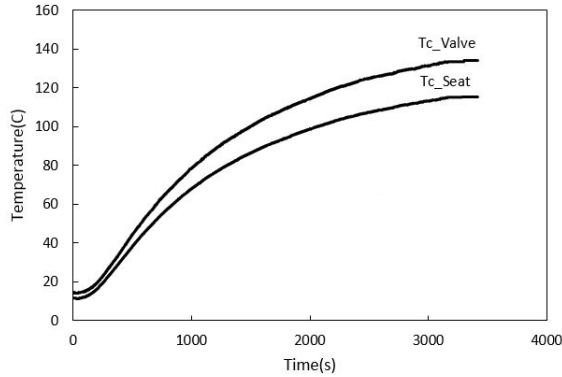

Figure 9. Temperature of contact surfaces for periodic contact with frequency of 210 rpm

The average temperature changes versus time for fix contact and periodic contact with a frequency of 210 rpm are shown in figure 10. According to the figure 10, it is seen that at the beginning of the experiment in which the temperature of both rods is low, the average temperature is low too, then the average temperature increases until reaching a quasi-steady state. The temperature distribution in the exhaust valve and seat for fix constant and periodic contact after reaching a quasi-steady

state is shown in figure 11. It is seen that in the contact region the temperature decreases due to an increase in the thermal contact resistance. Also, It can be seen that in periodic contact, the valve temperature increases, which is attributed to reducing in contacting time between the valve and the seat, which results that the contact time decreases and its temperature increases. The variation of temperature distribution in the valve and its seat in locations of thermocouples at various times depending on the placement of thermocouples for fixed and periodic contact are shown in figures 12 and 13, respectively. As it can be seen the temperature gradient in valve is higher than the seat, and the temperature gradient in periodic contact is more than fix contact, because due to the periodic contact, the valve and seat are not in contact with each other consequently, and all flux will not be transferred from the valve to the seat.

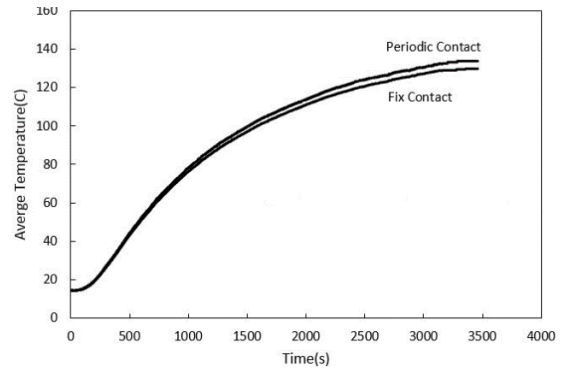

Figure 10. The average temperature at contacting surfaces for fix and periodic contact with frequency of 210 rpm

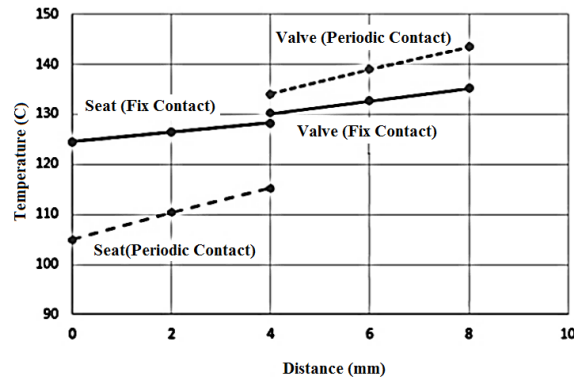

Figure 11. Temperature distribution in the vicinity of the contact surface for fix and periodic contact with frequency of 210 rpm

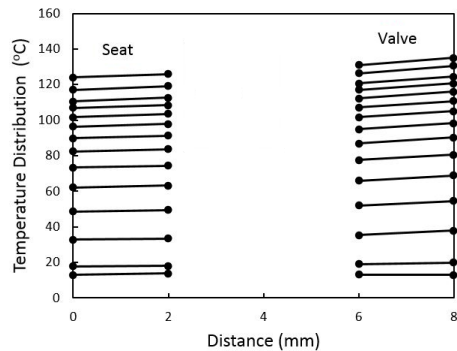

Figure 12. Temperature distribution in non-steady state in the exhaust valve and seat for fix contact

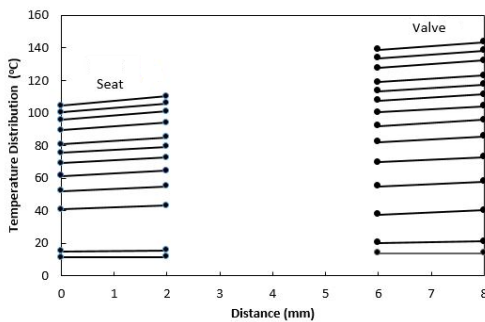

Figure 13. Temperature distribution in a non-steady state in exhaust valve and its seat for periodic contact with frequency of 210 rpm

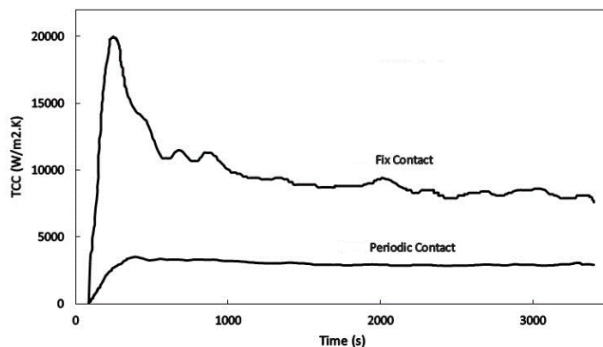

Figure 14. Thermal contact conductance for periodic contact with frequency of 210 rpm

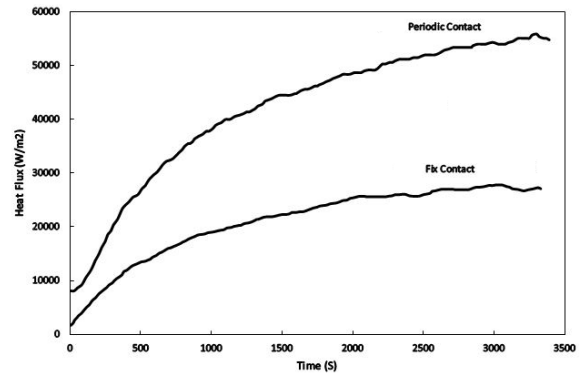

Figure 15. Heat flux changes between surfaces versus time for periodic contact with frequency of 210 rpm

Thermal contact conductance changes versus time are shown in figure 14. This coefficient is low at the beginning of the experiment and then increases gradually to reach a quasi-steady state. Despite filtering the temperatures as inputs to the analysis, there are small fluctuations in the coefficient of thermal contact and they are due to non-uniform heat flux due to periodic contact and also due to errors in the experimental data. Heat flux changes between surfaces versus time for fix and periodic contact with a frequency of 210 rpm is shown in figure 15.

For doing the sensitivity analysis, in this study, the input parameters are the contact pressure, contact frequency, heat flux between the exhaust valve and its seat and the cooling air speed. The only output parameter for sensitivity analysis is the thermal contact conductance (TCC). Table 1 shows the relative sensitivity amount of the thermal contact conductance (TCC) based on the changing in the input parameters. Also, Figs. 16-18 show the variation of the relative sensitivity versus different input parameters for 1, 2 and 3 increment percentage of input parameters, respectively.

Table 1. The relative sensitivity analysis (SL) of different input parameters

The increment percent \ Input parameter	1%	2%	3%
Contact pressure	25.65	56.24	87.53
Heat flux	1.88	3.55	6.27
Contact frequency	3.57	7.86	11.64
Cooling air speed	0.55	0.72	1.93

According to table 1 and figures 16-18, the contact pressure is the most sensitive parameters to TCC. After it, the contact frequency, heat flux, and the cooling air speed are the most sensitive parameters on TCC, respectively. So, when considering the TCC close attention should be done on the level of importance of the affecting parameters.

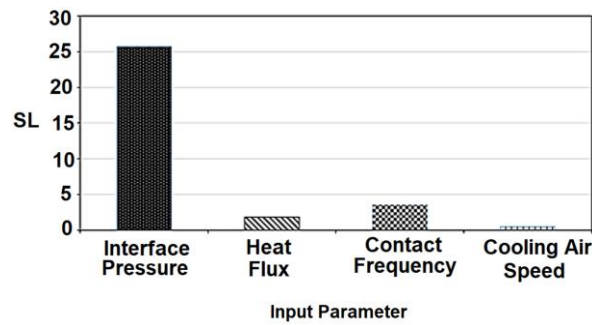

Figure 16. The relative sensitivity of the input parameters (1% increment)

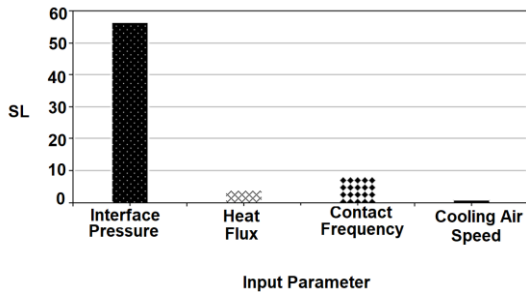

Figure 17. The relative sensitivity of the input parameters (2% increment)

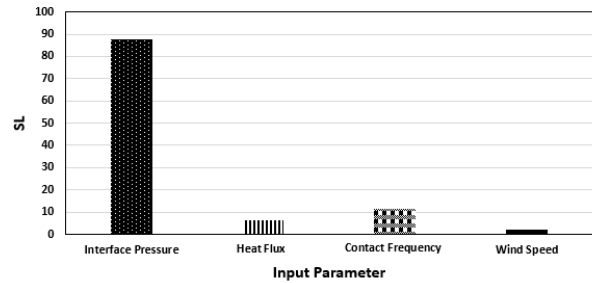

Figure 18. The relative sensitivity of the input parameters (3% increment)

6 Conclusion

In this study, the experiments were performed with aim to thermal analyze the exhaust valves in an Air-Cooled internal combustion engine of Wave 125 and to estimate the thermal contact conductance in periodic contact made. Due to the nature of internal combustion engines, the duration of contact between the valve and the seat is too short and too much time is necessary to reach quasi-steady state in periodic contact of the valve and its seat.

Finally, sensitivity analysis has been carried out on four important parameters that affect the thermal contact resistance. The results show that the contact pressure is the most sensitive parameter on TCC. After that, the contact frequency, heat flux, and the cooling air speed are the most sensitive parameters on TCC, respectively.

Acknowledgement

This research was supported by Automotive Research Center from Iran University of Science and Technology (IUST).

Nomenclature

h_c	thermal contact conductance, W/m ² K
k	thermal conductivity, W/m K
q	heat flux, W/m ²
T	temperature, K
R	result function
x	independent variable
W	uncertainty

Subscripts

c	contact
-----	---------

References

- [1] Annand, W. J. D., and Lanary, R. S., Heat Transfer Measurements on a Simple Model Representing a Popper Exhaust Valve in an Outflowing Stream, Journal of Mech. Eng. Science, Vol. 12, No. 3, 1970.
- [2] Sonoda, K., Iwasita, I., Kobayasi, K., Nakasi, H., and Yao, N., Heat Pipe Cooling of Exhaust Valve for Improvement in Hot Corrosion Resistibility, J. of the MESJ, Vol.24, No.9, 1989.
- [3] Paradis, I., Wagner, J., Marotta, E., Thermal Periodic Contact of Exhaust Valves in Spark Ignition Air-Cooled Engines, Journal of thermophysics and heat transfer, Vol. 16, No. 3, 2002.
- [4] Shojaefard, M. H., and Noorpoor, A. R., Theoretical and Experimental Analysis on Thermal Contact (Exhaust Valve), Doctoral Dissertation, Dep. of Automotive Engineering, Univ. IUST, Tehran, 2006.
- [5] Shojaefard, M. H., ghaffarpour, M., and Noorpoor, A. R., Thermal Contact Analysis Using Identification Method, Heat Transfer Engineering, 29(1):85-96, 2008.

- [6] Goudarzi, K., Shojaefard, M. H., and Fazelpour, M., Effect of Contact Pressure and Frequency on Contact Heat Transfer between Exhaust Valve and Its Seat, *Archive of SID*, Vol. 21, No. 4, 2008.
- [7] Mykhaylyk, V. B., Burt, M., Ursachi, C., and Wagner, A., Thermal Contact Conductance of Demountable in Vacuum Copper-Copper Joint between 14 and 100 k, *American Institute of Physics*, 2012.
- [8] Dongmei, B., Huanxin, C., Ye, T., Influences of Temperature and contact Pressure on Thermal Contact Resistance at Interfaces at Cryogenic Temperatures, *Cryogenics*, 2012.
- [9] Shojaefard, M. H., Mousapour, V. Kh., and Mazidi, M. Sh., The Investigation of the Influence of the Valve Spring Stiffness upon the Thermal Contact Conductance between the Exhaust valve and its Seat, *Heat Transfer Engineering*, Vol. 35, No. 13, January 2014.
- [10] Motahari-Nezhad, M., Shojaefard, M. H., Shahraki, S., Studying the Transient Thermal Contact Conductance between the Exhaust Valve and Its Seat Using the Inverse Method, *International Journal of Thermophysics*, 37-13, February 2016.
- [11] Motahari-Nezhad, M., Sh. Mazidi, M., An Adaptive Neuro-Fuzzy Inference System (ANFIS) model for prediction of thermal contact conductance between exhaust valve and its seat, *Applied Thermal Engineering*, 1-20, March 2016.
- [12] Shojaefard, M. H., Azarikhah, P., Qasemian, A., Experimental Investigation of Thermal Balance and Valve Cover Heat Transfer in a Small Internal Combustion Engine, *International Journal of Automotive Engineering*, Vol. 7, Number 2, June 2017.

- [13] Moses, W. M., An Experimental Investigation of the Heat Transfer across Periodically Contacting Surfaces, Ph.D. Dissertation, North Carolina State University, 1985.
- [14] Jacobs, C. M. J., and Bruin, H. R. D., The sensitivity of regional transpiration to land-surface characteristic: Significance of feedback, American Meteorology Society, 1992.